

Working environment: Healthy working  
TALO.S, LAMIGA and TENSA.NEXT

# HEALTHY WORKING HEALTHY LIVING

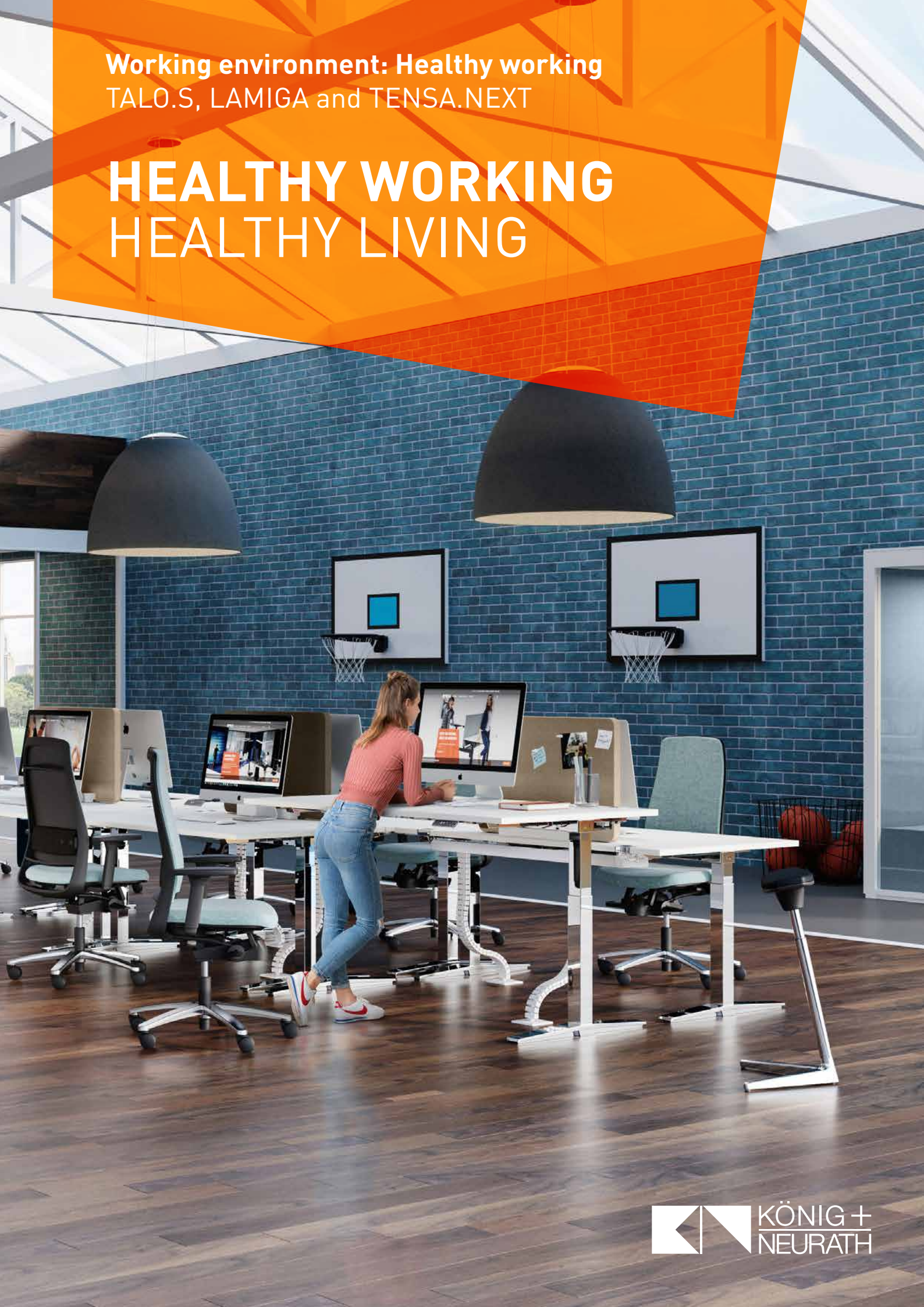

# Balance for body, mind and spirit - Our contribution towards healthy working

The World Health Organisation defines health as a state of physical, mental and social well-being. If all three are in harmony, then we are performing at optimum levels physically and psychologically.

As an employer you have a tangible benefit from promoting the health of your team: it's the only way to profit from the full potential of your workforce. As our rapidly changing world undergoes a sociocultural and demographic change, qualified employees are increasingly valued. It's worthwhile designing their working environment in such a way that it isn't just attractive, but also supports employee health. **In this brochure, we will show you some innovative ideas and creative design approaches that will also complement your work culture.**

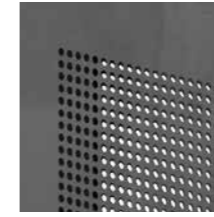
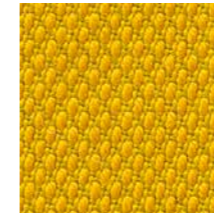
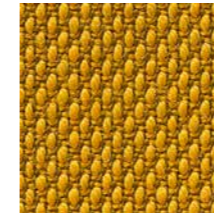

# MY HOME IS MY OFFICE

Working from home is not only more sustainable, kinder to the climate and more comfortable – it also reduces costs for the company. If the idea of home working is already integrated into the space concept plans, less space will be needed. At the same time employees have the advantage of being able to balance their job with their private life more efficiently: they can plan their time more flexibly or set their own priorities – and our solutions still give them the luxury of a workstation that adapts to their physical needs.

**Living or working? Both.** TALO.S and TENSA.NEXT form the work island in the middle of the living space, while the **meeting table**, our **MOVE.MIX chairs** and the **NET.WORK.PLACE bar stools** furnish a meeting room as elegantly as your dining room at home!



Products:  
TALO.S, TENSA.NEXT, NET.WORK.PLACE, MOVE.MIX, ACTA.PLUS

# WORKOUT AT THE WORKPLACE

Nowadays the fact that physical movement also activates the mind is well known. People are equally aware of the positive effect on your psyche and productivity if your body feels good. That's why companies are increasingly offering fresh meals, sports programmes, relaxation sessions and more – for healthy and happy employees.

## Our top three for a healthy workplace:

1. Ergonomic furnishing ideas
2. Separate areas for focused working, meetings and relaxation
3. Measures to promote health and sports activities at the office

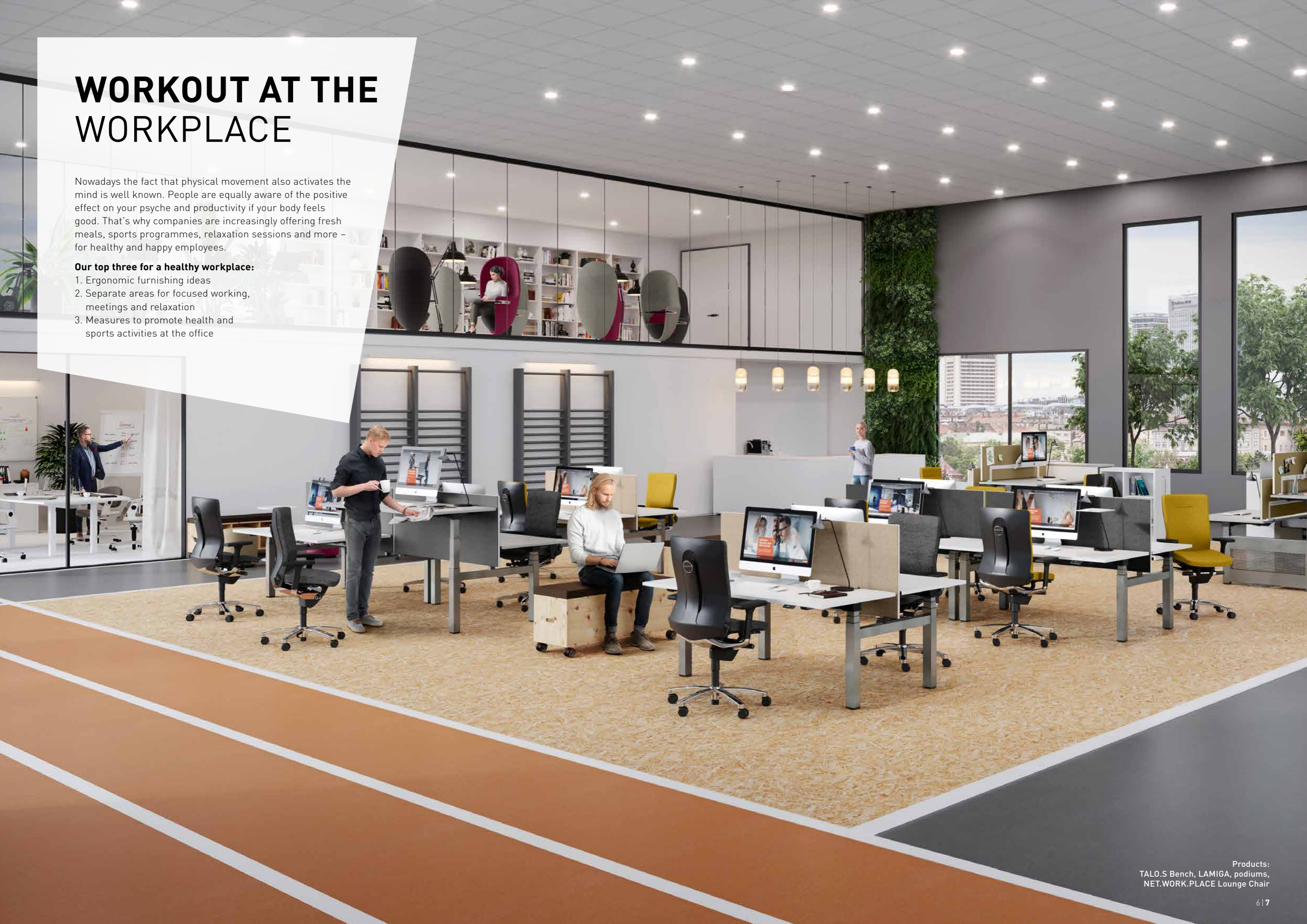



Products:  
TALO.S Bench, LAMIGA, podiums, NET.WORK.PLACE Lounge Chair,  
ACTA.PLUS side-access storage

**COAT HOOK**  
For storing clothing  
at the workplace

**K+N SMART.OFFICE WELLNESS encourages movement at your desk:** our digital tool reminds you to stand up and provides an analysis of your sit/stand activity, as well as the option of defining ergonomic goals. Personal settings are "portable" – they can be taken to a different desk. It can also be used anonymously.

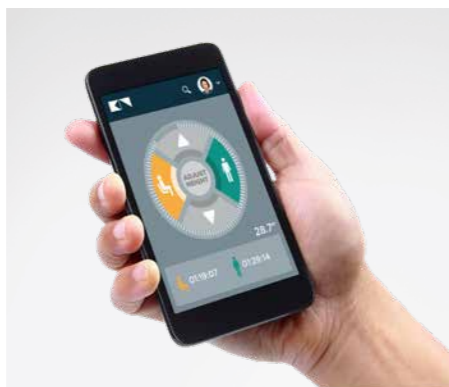

## KEEP MOVING!

Agile working and stand-up meetings – a dynamic approach is something you need in business. We also take inspiration from the fitness sector when we design and create our furniture and office outfitting. For instance our highly flexible swivel chair **LAMIGA** can be adjusted with almost the same precision as fitness equipment using the **ERGO-DISC**. **TALO.S**, shown here in the **Urban Style** look with **clear lacquer finish**, can easily be converted into a stand-up workstation to encourage movement. And when you use K+N SMART.OFFICE, it helps to keep you moving almost like a personal coach.

# MODERN OR CLASSIC? WE'RE THINKING SPORTY!

Today's working environments are generally much more mobile: people change jobs, locations and career goals more frequently. The office needs to be set up for that (as well as individual mobility). Here are some temporary workstations that adapt to their users in an instant. The project office with its open organisation system features a fitness zone in the hallway area, as well as a QUIET.BOX Duo for consultations, to take noise out of the open space – which is also a key aspect of health. **The TIMELESS style collection offers visual stability and a sense of calm as a counterpoint to the agile approach.**



Products:  
TALO.S, TENSA.NEXT, ACTA.PLUS, QUIET.BOX Duo

# GREEN LIGHT FOR PRODUCTIVE MEETINGS

There's proof that Nature has a restorative effect on health. Plants, air and light, as well as natural materials and colours, have a positive effect on body, mind and spirit. And it's relatively easy to put this concept into practice to achieve benefit. In a **conference situation**, in the **office** or in a **hotel lobby** – attractive finishes and natural materials improve wellbeing and health. We're convinced that our versatile **TALO.S series**, the **K+N BALANCE.CHAIR** that promotes dynamic sitting, and the organic forms of the **NET.WORK.PLACE Organic upholstered elements** boost productivity – wherever they are used!

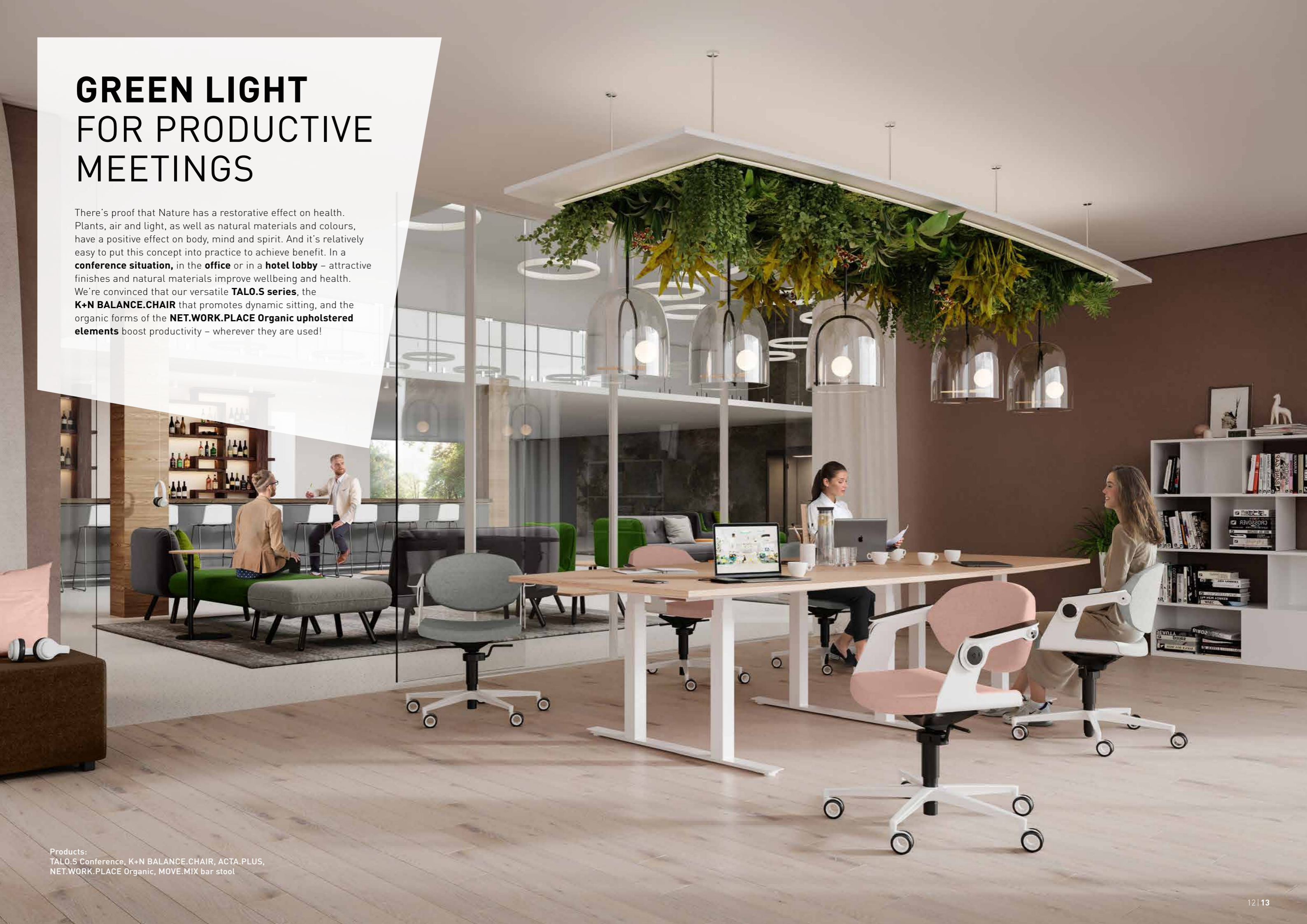

Products:  
TALO.S Conference, K+N BALANCE.CHAIR, ACTA.PLUS,  
NET.WORK.PLACE Organic, MOVE.MIX bar stool

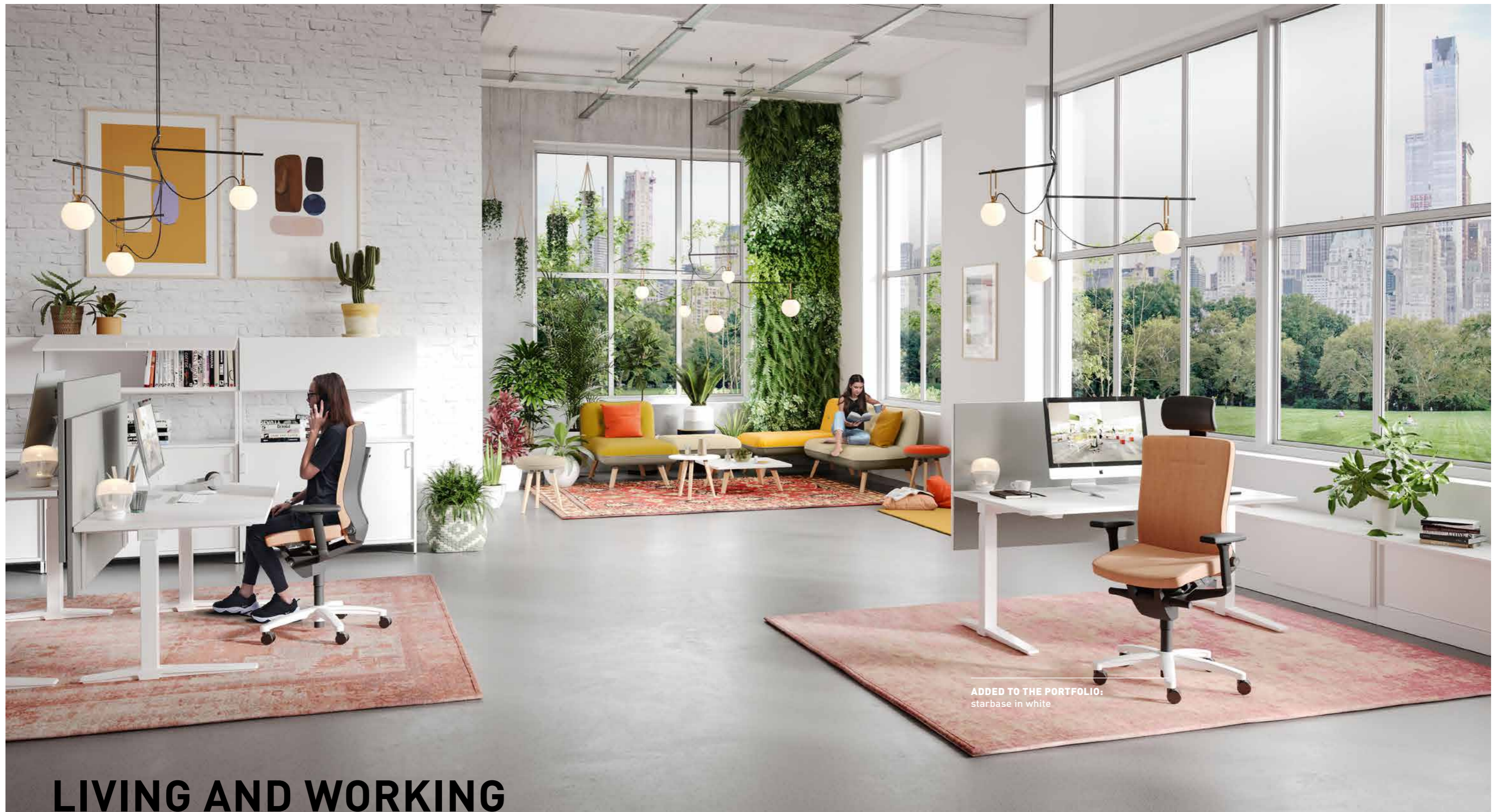

ADDED TO THE PORTFOLIO:  
starbase in white

# LIVING AND WORKING WITH THE FLOW

Something that seemed almost like utopia a few years back is already reality in many places: sofas for relaxing at the office. Opportunities to move around next to your desk. And a desk almost as beautiful as the one you have at home! Let's take a look at your work culture together and develop some solutions that are just right for your company. With spaces that ensure a **healthy balance between work, productivity and wellbeing**. With ideas for creating greenery, light and colour concepts – and furniture that reflects your corporate style and identity.

Products:  
TALO.S, LAMIGA, ACTA.PLUS, NET.WORK.PLACE Organic



Does your work culture  
include a healthy approach  
to working? We help you  
to encourage it!

TALO.S  
TENSA.NEXT  
LAMIGA

# REAL TEAMPLAYERS

## TALO.S

- + Sitting/standing workstation
- + Available as a **single workstation, bench** or **conference system**
- + T-frame desking range in 70 x 70 mm square tube
- + **3 types of height adjustment:** adjustment at 10 mm intervals via hand wheel, gas-lift (no power required), electric adjustment
- + Smooth-running sliding top
- + Fixed or clip-down cable tray
- + Detachable table top by means of clips
- + Practical wire management horizontal through cable tray, vertical via cable trim and cable chain
- + Variety of extensions and accessories
- + Suitable for K+N SMART.OFFICE



# TALO.S, LAMIGA AND TENSA.NEXT

## LAMIGA

- + The **flexible backrest** supports the body during lateral rotation
- + Backrest can be adjusted via the **integral ERGO-DISC**
- + Seat tilt adjustment: max. 4° forward tilt, seat depth through 50 mm with 6 locking positions
- + Flexible front edge lowers when you sit down, improving the circulation in the legs
- + To take the strain off the lower back the optional lumbar support can be adjusted in height and depth
- + Quick-set weight adjustment
- + Tested for user weights **up to 150 kg**



## TENSA.NEXT

- + The DTS synchro mechanism (Dynamic Torsion System) to optimise the motion sequence and ensure dynamic sitting
- + **Ergonomic:** opening angle of 24° and optimum synchro ratio of 1:2
- + The lowering of the front edge of the seat prevents pressure points on the thighs
- + The **proactive forward-tilt adjustment** tilts the seat forward by 4° and the backrest by 8°
- + Adjustable lumbar support available in two variants
- + Slender strip at the top of the backrest, facilitates moving the chair around
- + Individual weight setting, from **45 to 120 kg**



# TALO.S WITH EXTRAS

**FABRIC-COVERED DESK SCREEN**  
For desks with integral adaptors  
Screen thickness 25 mm and  
50 mm absorber class A (on one side)

**ORGANISER RAIL**  
For sturdy mounting of flat screen  
monitor brackets or shelves

**MODESTY PANEL, METAL**  
Privacy screen with perforated  
pattern, retrofittable

**"PUSH-TO-OPEN" CABLE COVER**  
For direct access to data and power

**CPU BRACKET, METAL**  
Can be fitted inside  
or outside the frame

**CABLE DUCT WITH  
CABLE CHAIN**  
For vertical wire management  
of motorised desks

**SMOOTH-RUNNING  
SLIDING TOP**  
Free access to  
cables from above

**CABLE CHAIN**  
No messy cables  
under the desk

**CABLE TRIMS**  
For vertical wire management  
of lift and motorised desks

**FABRIC-COVERED DESK SCREEN  
WITH ORGANISER RAIL**  
For sturdy mounting of flat screen  
monitor brackets or shelves  
Screen thickness 25 mm

**ADAPTER WITH INTEGRAL  
CABLE MANAGEMENT**  
For retrofitting a third level

**DESKTOP ELECTRICS**  
With adhesive fastening or clip-on

**SPACIOUS CABLE TRAY  
IN TWO HEIGHTS**  
For max. cable volumes incl.  
direct link for cable chain

**PRINTER TRAY**  
Retrofittable

# TALO.S AS A TEAM WORKSTATION

**FABRIC-COVERED CENTRAL PANEL**

**FABRIC-COVERED DESK SCREEN WITH INTEGRAL TOOL RAIL**  
For bench systems with integral adaptors

**ORGANISER RAIL**  
For sturdy mounting of flat screen monitor brackets or shelves

**CABLE CHAIN**

**SIDE TRIM**  
Perforated

**SIDE TRIM**  
Non-perforated

**CABLE TRAY**  
Beneath desk top

**SMOOTH-RUNNING SLIDING TOP**  
Free access to cables from above

**CENTRAL CABLE TRAY**  
Beneath desk top

**ELECTRICS CUT-OUT**  
With brush seal and tool-rail to hold flat screen monitors

**CLAMP-ON SIDE PANEL**  
For visual screening

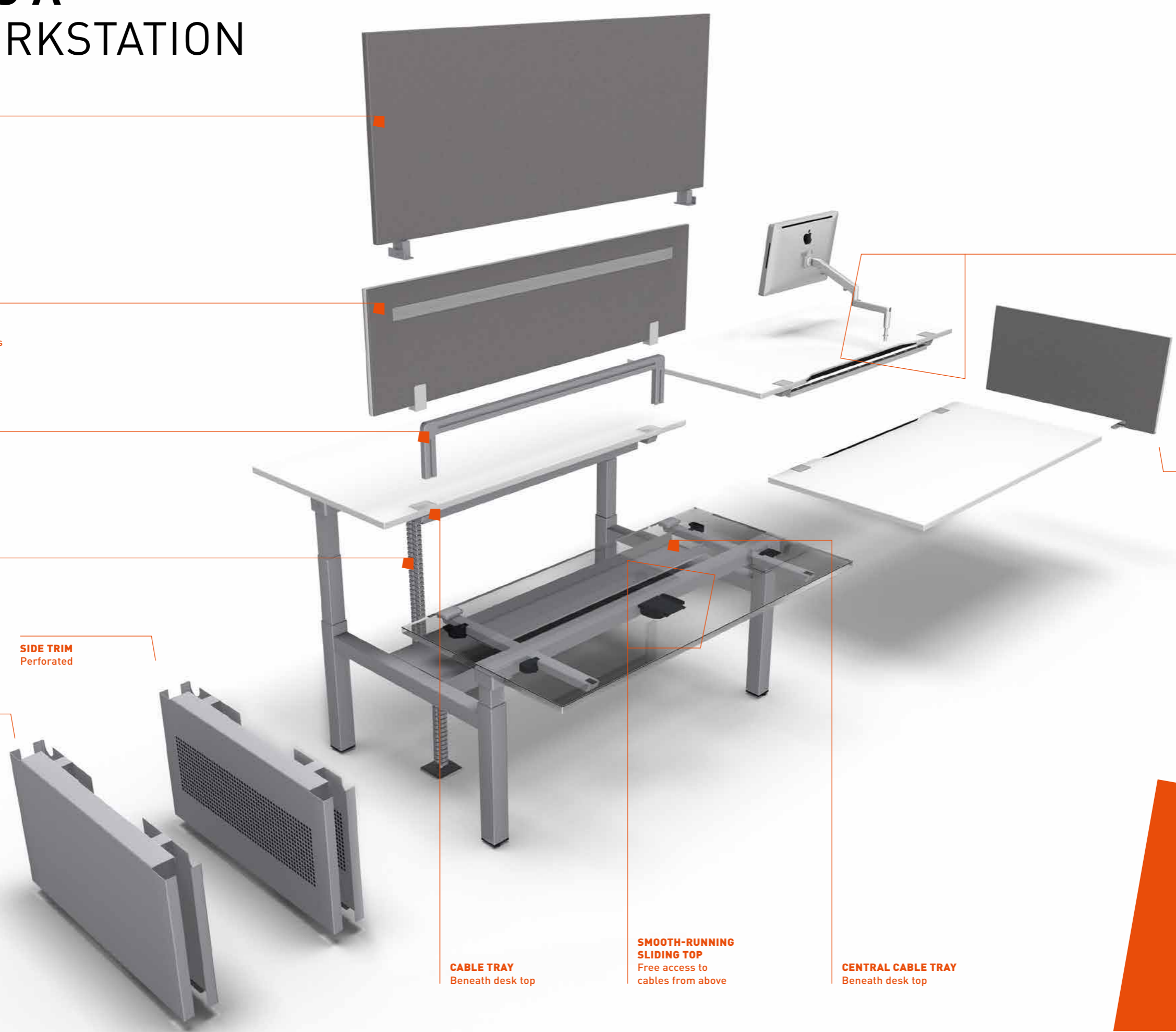

**DISCOVER**  
more screen variants for visual and acoustic protection in our product portfolio.

# EVERYTHING'S ADJUSTABLE INCLUDING THE DESK HEIGHT



## Handwheel

Manual tool-free height adjustment in increments from 650 – 850 mm



## Adjustable gas lift

Fast height-adjustment, no power source required, from 680 to 1180 mm for:

- + 20 kg (+/- 10 kg) or
- + 40 kg (+/- 10 kg) useful load
- + with a useful load pre-set of max. 50 kg



## Motorised

Convenient, infinitely-variable adjustment from 650 – 1250 mm or 680 – 1180 mm with integral collision prevention

# FOR NEW PERSPECTIVES IN THE OFFICE

There are lots of variables that can turn a workstation into a healthy one. One key factor is posture: if the furniture provides optimum support for the muscular system, asymmetrical stress can be avoided. You can also strengthen muscles and boost mental agility with dynamic sitting, as well as switching between sitting and standing.

## Advantages of a sitting/standing workstation

- + Strengthens the stomach and leg muscles
- + Relieves the strain on the spine and discs
- + Improves circulation in the legs
- + Relaxes the muscles
- + Higher level of activity
- + Improved body awareness
- + Better health

# K+N SMART.OFFICE

## Take your place in the agile work culture – with a smart, stress-free approach

How can we organise rooms and processes efficiently even though people are working everywhere? How can we empower agile project teams so that they can work within a structure whilst remaining healthy? **K+N SMART.OFFICE** networks the room, furniture and people together, turning challenges into opportunities.

**K+N SMART.OFFICE** is a digital service that provides a simple way of organising space so that it's used efficiently. To achieve this, sensors are installed in rooms and on furniture. **K+N SMART.OFFICE** can be used via a phone app or from the desktop.

The system includes modules that you can integrate into your infrastructure individually or in combination.



With the

## K+N SMART.OFFICE COMPANION

it's easy for employees to book rooms and workstations which makes organising dynamic work cultures efficient.

- + Find and book vacant desks and meeting rooms
- + Filter by number of people and equipment
- + Touch screen in the meeting rooms, instant booking option
- + Find colleagues

With the

## K+N SMART.OFFICE STUDY

you can make space and furniture use transparent and highlight potential for optimisation – to plan space use more efficiently.

- + Identify the full potential of space and resource utilisation
- + View data in real time
- + Use comprehensive analysis for new, efficient room and space planning

Discover now at  
[smart-office.de](https://smart-office.de)

# DETAILS



**1 | FABRIC-COVERED DESK SCREENS**  
Provide visual privacy at the workstation with optional railing or tool rail.

**2 | CABLE DUCT WITH CABLE CHAIN**  
Houses vertical electrics for motorised and lift desks.



2

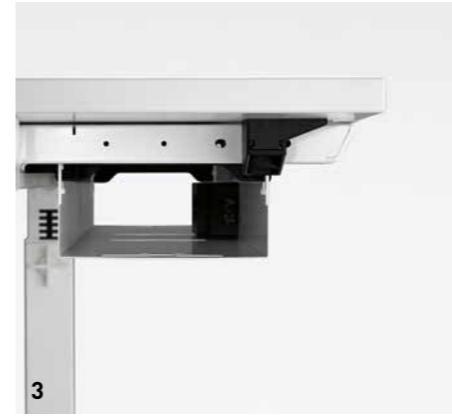

**3 | SPACIOUS CABLE TRAY**  
The electric unit is accessible for easy cabling.

**4 | CABLE TRAY IS HINGED AT BOTH SIDES**  
On standard desks without sliding top.



**5 | "PUSH-TO-OPEN" CABLE COVER**  
Rapid access to socket bar with various configuration options.

**6 | CPU HOLDER**  
Can be fitted to the inside or outside of leg frame.

**7 | OPERATING CONSOLE**  
In two variants for motorised height adjustment.



6

6

**8 | ELECTRICS CUT-OUT**  
With brush seal and tool rail to hold flat screen monitors. Also suitable for bench systems.

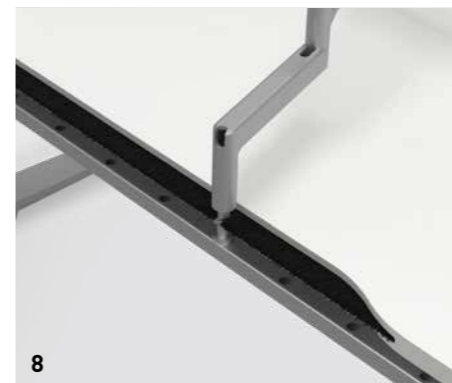

8

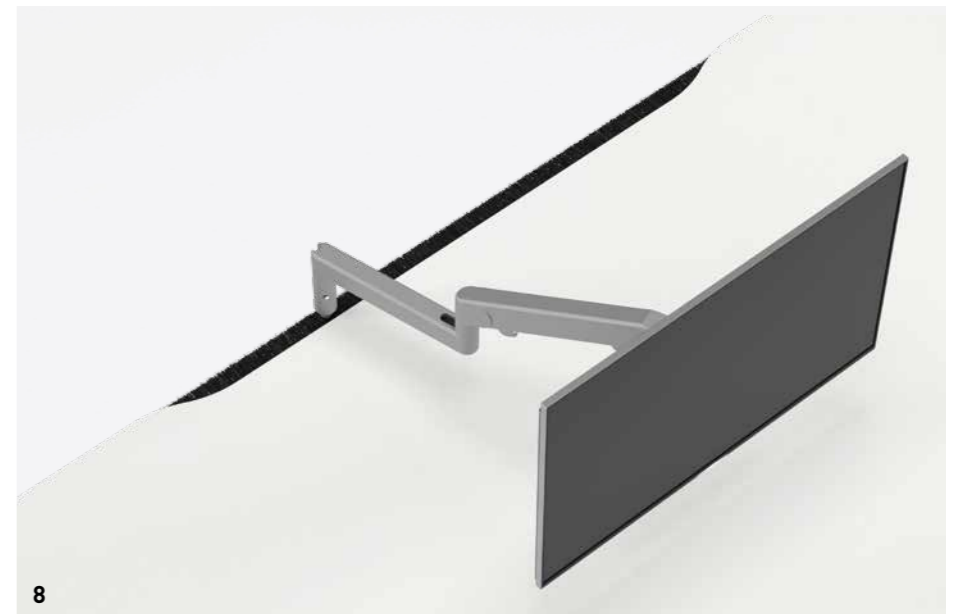

8

# DETAILS BENCH

**9 | STURDY TOP CLIPS**  
For tool-free assembly of the desktop.



9

**10 | SMOOTH-RUNNING SLIDING TOP**  
Allows convenient access to cables from above, fast and efficient.



10

**11 | DESK DEPTHS**  
800 mm deep on asymmetrical frames, 900/1000 mm deep on symmetrical frames.



11



11

**12 | VARIABLE MODESTY PANEL**  
For visual screening, with perforated pattern, attached via a bracket.



12

**13 | CLEAR LACQUER LEG FRAME FINISH**  
With visible weld points.



13

**14 | ADJUSTABLE GAS LIFT DESK**  
Height-adjustment, no power source required, from 680 to 1180 mm for +/- 20 kg or +/- 40 kg or with customised weight setting up to 50 kg for desk depths of 800 mm or 900/1000 mm.



14



14



16

16



15

**15 | CENTRAL SCREEN FOR PRIVACY**  
The effective screen provides privacy as well as offering acoustic advantages.

**16 | FUNCTIONAL SIDE TRIM**  
Optionally either perforated steel or closed to accommodate cables.

**17 | FLEXIBLE CABLE MANAGEMENT**  
Electrics pass through umbilicals to the central cable tray and down to the floor.



16











17

# FINISHES

## DESK TOP SURFACES

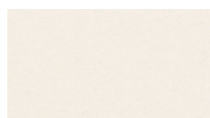
MFC SOLID COLOUR	MFC WOOD EFFECT	VENEER	FENIX
 GK Grey	 AA Acacia	 AH Canadian maple unstained	 7V Fenix black
 GW Off-white	 AO Maple	 BH Beech unstained	 7M Fenix white
 KH Light grey	 ET Oak natural	 CK American cherry	 7J Fenix dark grey
 9R Medium grey	 MB Beech	 EN Oak natural	 7I Fenix dark beige
 9T Beige	 NM Walnut	 SN American walnut natural	
 KT Aluminium coloured	 9L Halifax Oak Natural		
 WI Pure white	 9S Concrete look		

## FRAME COLOURS

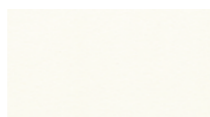
POWDER-COATED METAL	TEXTURED FINISH
 AL Aluminium coloured	 KSS Black
 AM Anthracite metallic	
 GC Chrome	
 GK Grey	
 GW Off-white	
 KH Light grey	
 KS Black RAL 9011	
 PK Metal clear varnish	
 WI Pure white	

# PRODUCT OVERVIEW



Legs/Frame		Single desk	Bench
T-frame, square tube		■	■
<b>Dimensions individual workstation</b>			
Widths	800, 1000, 1200, 1400, 1600, 1800, 2000 mm	■	-
Depths	600, 800, 900, 1000 mm	■	-
<b>Bench dimensions</b>			
Widths	1600, 1800, 2000 mm	-	■
Depths	1680, 1880 mm	-	■
<b>Height adjustments</b>			
Height-adjustable	650 – 850 mm	■	■
Gas lift	680 – 1180 mm with adjustable useful load from 0 – max. 50 kg (depending on desk size) 680 – 1180 mm for 20/40 kg useful load (+/- 10 kg)	<input type="checkbox"/>	-
Electric motor	650 – 1250 mm double telescope optional 680 – 1180 mm, double telescope	<input type="checkbox"/>	<input type="checkbox"/>
<b>Worktops</b>			
Chipboard	25 mm thick MFC sliding top, removable without tools	■	■
Veneer		■	■
<b>Variants</b>			
	Single desks, linking (for height-adjustable desks only)	■	-
	Team tables for bench systems	-	■
<b>Wire management</b>			
Electrics cut-out	With brush seal and tool rail	<input type="checkbox"/>	<input type="checkbox"/>
Horizontal	Optionally available with matching cable tray or cable management clips	<input type="checkbox"/>	<input type="checkbox"/>
Vertical	Additional vertical cable trim or cable chain	<input type="checkbox"/>	<input type="checkbox"/>
Cut-outs/adapters	For selected desk top shapes	<input type="checkbox"/>	-
Sliding top	For selected desk top shapes	■	■
Clip-down cable tray, opens both sides	Optionally available for desks without sliding top	<input type="checkbox"/>	-
"Push-to-open" cable cover	Optional "push-to-open" cable cover 400 x 166 mm; incl. plate with pre-fitted 4-gang socket (3x type F, 1x RJ 45); left or right for 1600 – 2000 mm, central for 1200 – 1400 mm	<input type="checkbox"/>	-
<b>Accessories</b>			
3rd level	As option via adapter	<input type="checkbox"/>	<input type="checkbox"/>
At the side	Extension tops, CPU holder, printer tray, side trim perforated steel or closed	<input type="checkbox"/>	<input type="checkbox"/>
Below the top	Modesty panel	<input type="checkbox"/>	-
Linked configuration	Possible as option using a variety of different linking modules for 800 mm deep desks	-	<input type="checkbox"/>
Railing	Railing with tool rail to hold storage accessories or flat screen arms; fabric panel, with organiser slots on both sides	<input type="checkbox"/>	-
Desk screens	Covered with fabric with acoustic properties	-	<input type="checkbox"/>
Fly-by screens	For installation behind the desk	<input type="checkbox"/>	-

■ Standard □ Optional

Subject to technical and programme alterations, printing and other errors. Printed colours may vary from actual colours.





# TENSA.NEXT



**CLOTHES HANGER**  
Optional.



**HEADREST (optional)**  
Can be individually adjusted in height, depth and angle in one move, ensuring a relaxed and upright position regardless of sitting posture.



**MULTI-ADJUSTABLE**  
The comfortable armrests are adjustable in height, width and depth and have a swivelling pad.

**BACK FRAME**  
With slender strip to facilitate moving the chair.

**LUMBAR SUPPORT**  
For upholstered and mesh backrests. Can be retrofitted.

**MOVEABLE SEAT**  
Dips below the backrest.

**INNOVATIVE MECHANISM**  
DTS synchro mechanism with customised weight setting from 45 to 120 kg.

**STARBASE**  
Available in various versions.

# DETAILS

## 1 | BACKREST STYLES

The comfortable backrest is available in fully upholstered, mesh fabric, 3D-fabric and textured versions.

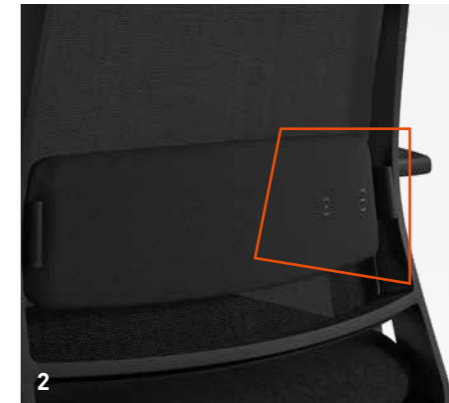

## 2 | TWO TYPES OF LUMBAR SUPPORT TO CHOOSE FROM

The lumbar support with fixed curvature (pictured on the left) is height-adjustable. The inflatable version (pictured on the right) can be adjusted in height and curvature.

## 3 | SEAT TILT ADJUSTMENT

The seat lowers when adjusted to keep the pelvis in an upright position, taking the weight off the spine.



## 4 | ADJUSTABLE ARMRESTS

The height and supporting surface of the ergonomic multifunctional armrests can be individually adjusted.



## 5 | SPORTY DESIGN

The adjustable seat surface dips below the backrest, adding an elegant touch.



## 6 | DTS SYNCHRO MECHANISM

Supports a synchronous sequence of movements, a crank allows the counter pressure to be adjusted for user weights from 45 to 120 kg.



## 7 | STARBASE STYLES

Types available: black plastic, powder-coated aluminium, polished, chrome finish. Castors are available for both carpets and hard floors.



# PRODUCT OVERVIEW



## Technology

Mechanism	DTS synchro mechanism (Dynamic Torsion System)	■
Opening angle	24° (maximal 32°)	■
Synchro ratio	1:2	■
Individual weight adjustment	45 to 120 kg	■
Seat height adjustment	420 to 515 mm	■
Seat depth adjustment	50 mm, 6 positions	■
Seat tilt adjustment	Proactive: seat 4°, backrest 8° forward tilt	■
Backrest lock	3 positions	■
Seat	Upholstered	■
Integral shock absorption	Yes	■

## Backrest

	Mesh fabric	■
	3D-mesh fabric	■
	Upholstered pad	■
	Ribbed fabric	■
Two types of lumbar support	Inflatable, adjustable in height and depth	<input type="checkbox"/>
	Fixed curvature, height-adjustable	<input type="checkbox"/>
Headrest	Adjustable in height and width, optionally available in leather even on a fabric chair	<input type="checkbox"/>

## Armrests

4D multifunctional armrests	Adjustable in height, width and depth, armrest pads swivel	■
	Optional with leather armrest top	<input type="checkbox"/>

## Dimensions

Seat height	420 to 515 mm
Seat width	480 mm
Seat depth	390 to 440 mm
Back width	500 mm
Back height	670 mm
Total width incl. armrests	678 mm
Total depth	645 mm

## Colours

Plastic parts	Black
Starbases	Black plastic
	Aluminium (2 types of spokes)
	Powder-coated, polished aluminium or chrome
Castors (for carpeted or hard floors)	Black

■ Standard  Optional

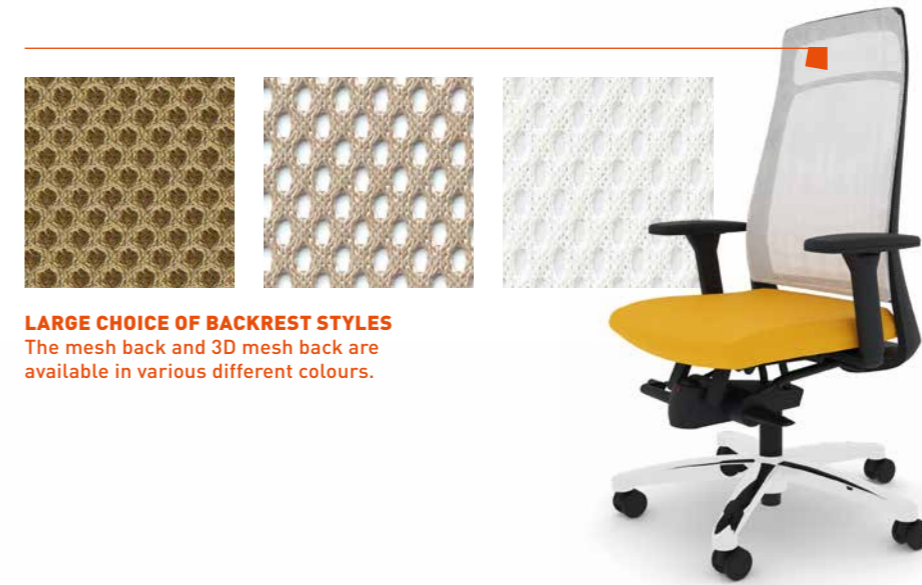

**LARGE CHOICE OF BACKREST STYLES**  
The mesh back and 3D mesh back are available in various different colours.



**SELECTION OF FABRICS**  
Materials are available in many colours and textures, to match corporate identity.

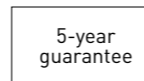

# LAMIGA

**NECK SUPPORT (optional)**  
Can be adjusted in height, depth and tilt. It ensures a relaxed and upright position regardless of sitting posture.



**CLOTHES HANGER**  
Optional.

**ARMRESTS**  
Can be individually adjusted in height, width and depth, relieving strain on the shoulders and neck muscles. The armrest pad can be swivelled and locked in place.

**OPENING ANGLE**  
Maximum seated comfort thanks to four adjustable positions.

**SYNCHRO MECHANISM**  
Synchronous movement of seat and backrest.



**ERGO-DISC**  
For automatic adjustment of backrest counter-pressure.

**LUMBAR SUPPORT**  
To stabilise the back, can be adjusted in various ways.

**WEIGHT ADJUSTMENT**  
The quick-set weight adjustment goes from light (45 kg) to heavy (150 kg) in just 3 rotations.

# DETAILS



1

### 3 | VERSATILE ARMRESTS

The 4D multifunctional armrest has various adjustment features and the option of locking the armrest pad in position to avoid unintentional adjustment.

### 4 | VARIABLE OPENING ANGLE

The opening angle of 24° can be set at 0°, 8° and 16°.



2

### 1 | TWO VERSIONS

Backrest with black plastic shell, neck support optional.

### 2 | BACKREST CAN BE ADJUSTED VIA ERGO-DISC

The ERGO-DISC controls the counter-pressure of the flexible backrest.



3

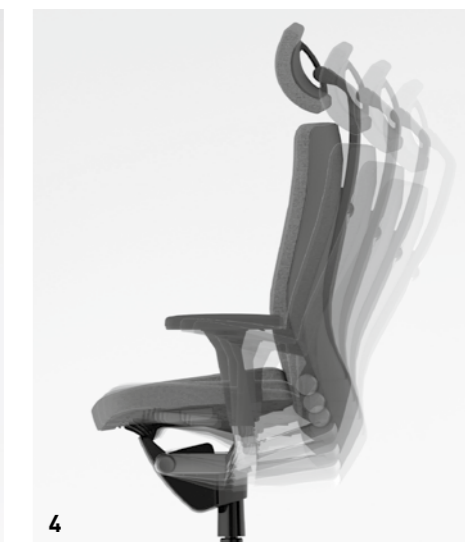

4



5



5



6

### 5 | ADJUSTABLE LUMBAR SUPPORT

It is adjustable in height and curvature and offers additional support in the lower back area.

### 6 | FRONT EDGE OF SEAT CAN BE LOWERED

The flexible front edge of the seat dips when the user changes position, improving the circulation in the legs.



7



7

### 7 | STARBASE STYLES

The starbases are available in steel or aluminium with various finishes.

TESTED  
FOR USERS  
WEIGHING  
UP TO 150 KG

designed by

**ITO® DESIGN**

# PRODUCT OVERVIEW



## Technology

Mechanism	Synchro mechanism	■
Opening angle	24°	■
Synchro ratio	1:2,3	■
Individual weight adjustment	45 to 150 kg	■
Seat height adjustment	420 to 520 mm	■
Seat depth adjustment	Through 50 mm, 6 positions	■
Seat tilt adjustment	4° forward tilt	■
Limit to opening angle	In 4 locking positions: 0°, 8°, 16°, 24°	■
Seat upholstery	Foam	■
Integral shock absorption	Yes	■

## Backrest

	Upholstered plastic seat/back shell	□
ERGO-DISC	Flexibility of backrest rotation infinitely variable	□
Lumbar support	Schukra®, adjustable in height and curvature	□
Neck support	Adjustable in height, tilt and depth	□

## Armrests

4D multifunctional armrests	Adjustable in height, width and depth, armrest pads can be swivelled and locked in place (without tools)	□
	Optional with leather armrest top	□

## Dimensions

Seat height	420 to 520 mm	■
Seat width	475 mm	■
Seat depth	400 to 450 mm	■
Back width	455 mm	■
Back height	605 mm	■

## Colours

Back and seat shell	Black	■
Back support	Black	■
ERGO-DISC	Same colour as back support, decorative ring in chrome	■
Mechanism rocker	Black / aluminium / anthracite metallic	■
	Polished aluminium / chrome	□
Armrests	Black	□
	Armrest support black	■
	Polished aluminium / chrome	□
Starbases	Steel with black plastic cover	■
	Aluminium, flat spokes in black / aluminium-coloured / anthracite metallic	■
	Polished aluminium / chrome	□
Castors (for carpeted or hard floors)	Black or black/grey, 60 mm diameter	■

■ Standard □ Optional



5-year guarantee



### Side-access storage

Attractive design and well-organised inside. Now also available with coat hook.



reddot award 2018 winner

### K+N BALANCE.CHAIR

The patented office chair can be converted quickly into a leaning support in just a few movements.

As a leading brand for office furniture and room systems, König + Neurath develops solutions for individual work cultures

Together with specialist retailers, König + Neurath supports its customers throughout the entire process of outfitting offices. With differentiated style collections, design-conscious furniture and digital solutions, the family-owned company, established in 1925, helps its customers to adapt successfully to the changing nature of the workplace.



### Podiums

Flexible modules for creative interaction.



### NET.WORK.PLACE Organic

Modular upholstery elements for reception and communication areas.



### NET.WORK.PLACE

Modular and practical upholstery elements for areas in which to retreat, relax and receive visitors.

**Deutschland**

König + Neurath AG  
Industriestraße 1-3  
61184 Karben  
T +49 6039 483-0  
info@koenig-neurath.de

**Great Britain**

König + Neurath (UK) Ltd.  
Ground and Lower Ground Floor  
75 Farringdon Road  
London EC1M 3JY  
T +44 20 74909340  
info@koenig-neurath.co.uk

**Nederland**

König + Neurath Nederland  
Beethovenstraat 530  
1082 PR Amsterdam  
T +31 20 4109410  
info@konig-neurath.nl

**France**

König + Neurath AG  
53, rue de Châteaudun  
75009 Paris  
T +33 1 44632393  
info@koenig-neurath.fr

**Schweiz**

König + Neurath (Schweiz) GmbH  
St. Gallerstrasse 106 d  
CH-9032 Engelburg / St. Gallen  
T +41 52 7702242  
info@koenig-neurath.de

**Österreich**

König + Neurath AG  
Gonzagagasse 1 / Morzinplatz  
1010 Wien  
T +43 676 4117512  
info@koenig-neurath.de

