

alea

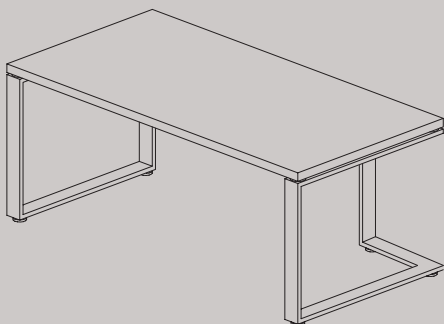

Archimede

direzionali | executive | mobilier de direction | ejecutivos

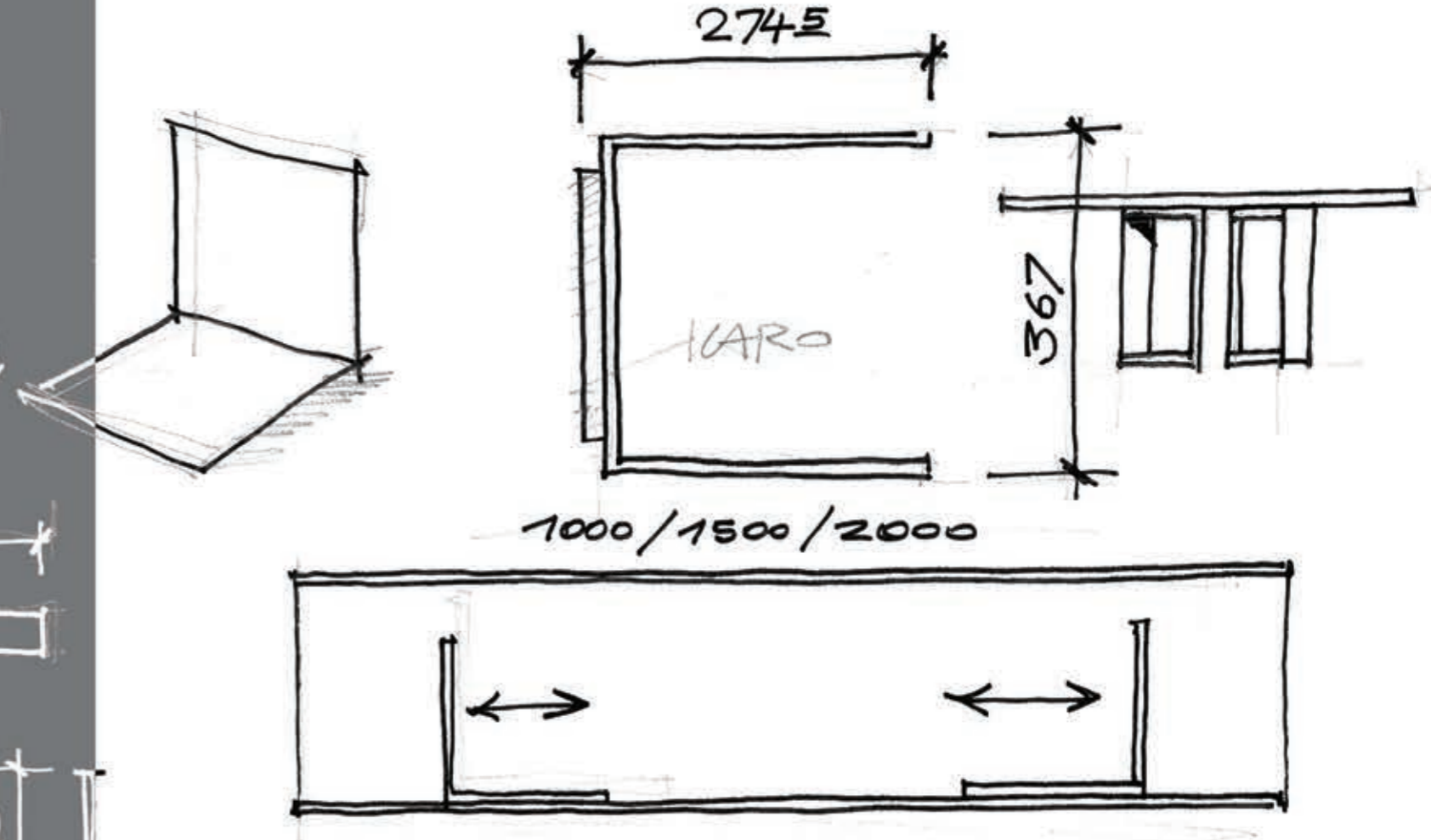
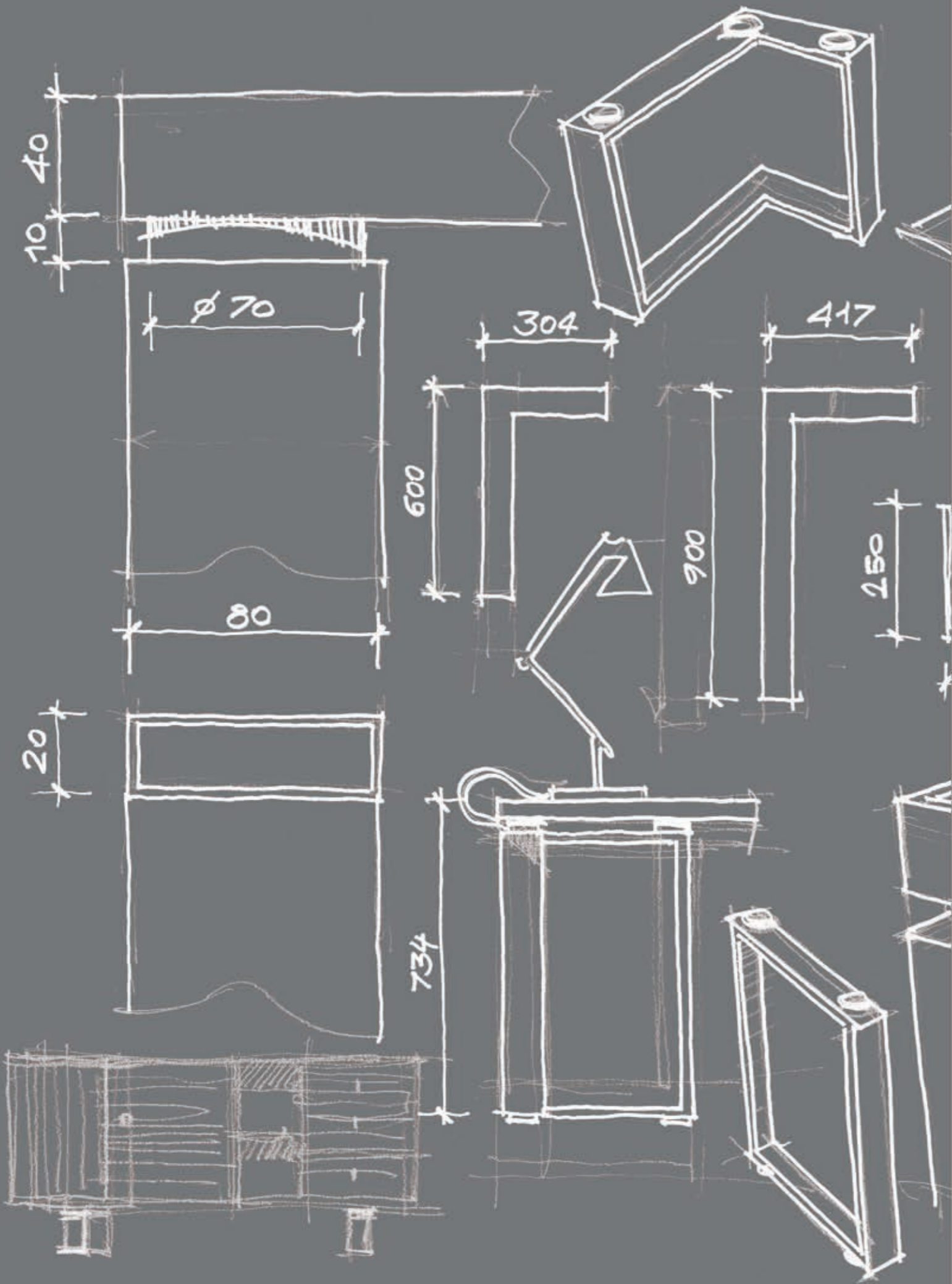

Nuovi componenti e finiture: ARCHIMEDE rinnova la sua immagine e moltiplica le proprie soluzioni di arredo. Il design si mantiene lineare e contemporaneo, con i piani lavoro ortogonali abbinati alla gamba strutturale ad anello o a quella 'irregolare', ma sono state aggiunte nuove opzioni estetiche (come la cornice 'brill' anche per i piani lignei) e strutturali (il contenitore laterale che funge da supporto al piano lavoro).

A new look and more design solutions for ARCHIMEDE. The design is still contemporary, with work surfaces perpendicular to both the supporting ring leg and "L-shape". New styles & structural options have been added such as the "brill" (polished aluminum) frame for wood tops and a side cabinet supporting the desk surface.

Nouveaux composants et finitions: ARCHIMEDE renouvelle son image et multiplie les solutions d'aménagement. Le design reste lineaire et contemporain, avec des plateaux orthogonaux en harmonie avec le piétement structurel en anneau ou à celui "irregulier". De nouvelles options esthétiques (comme le cadre "brill" disponible également pour les plateaux en bois et structurels (le caisson lateral qui devient support du plateau)

Nuevos componentes y acabados: ARCHIMEDE renova su imagen y multiplica sus soluciones de decoración. El diseño sigue siendo contemporáneo y estilizado, con las superficies de trabajo ortogonales que se combinan a la pata estructural en anillo o a la "irregular". Se han añadido nuevas opciones estéticas (como el marco "brill" también para los sobres en melamina y madera) y estructurales (el contenedor lateral que funciona como soporte al sobre de trabajo)





MATÉRIEL & DESIGN

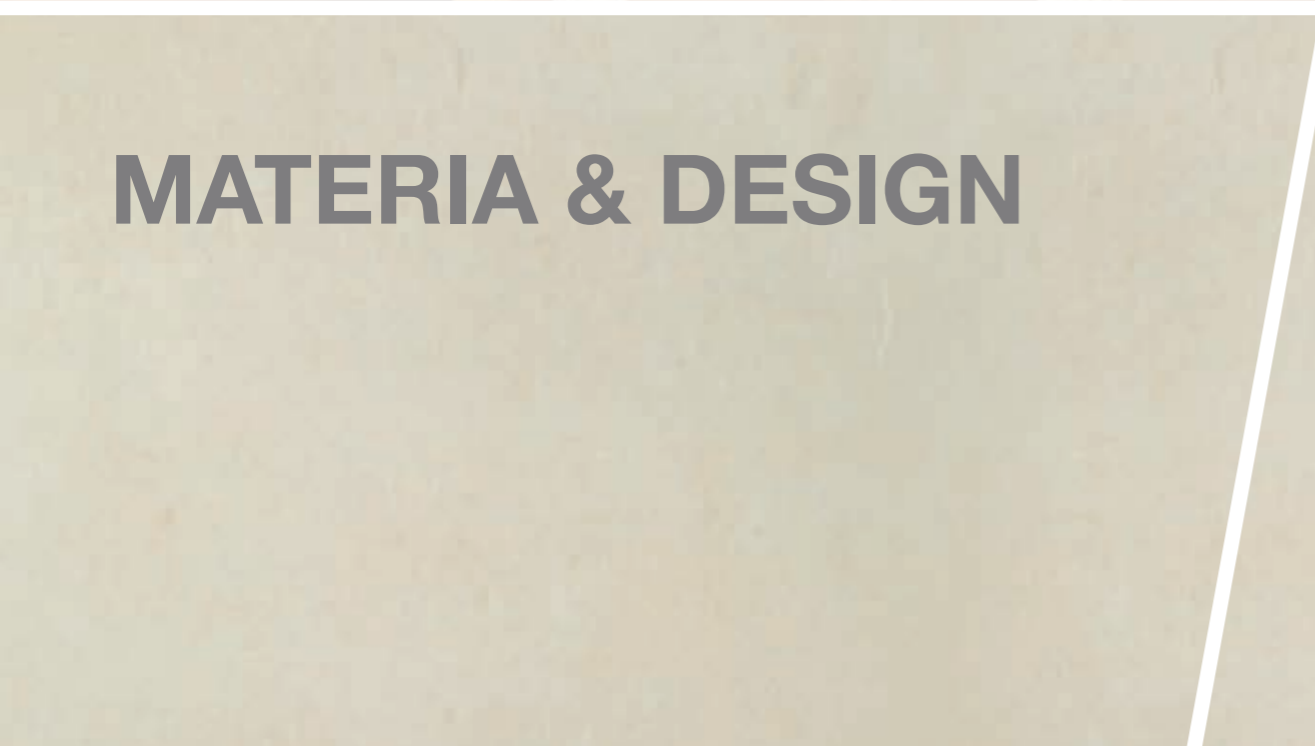

MATERIA & DESIGN

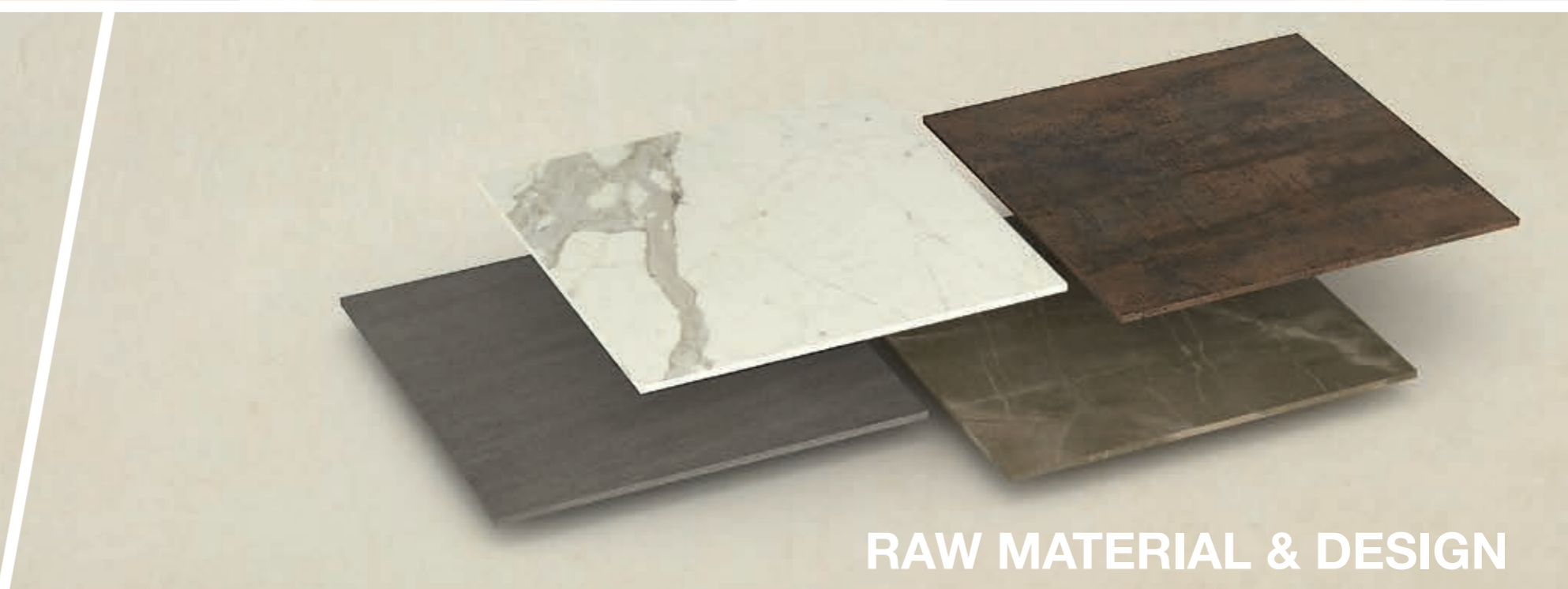

RAW MATERIAL & DESIGN



MATÉRIEL & DESIGN

Il cuoio è il materiale più prestigioso per il tavolo direzionale. ARCHIMEDE lo propone sui piani lavoro in vari colori con cuciture tinta Grigio Perla, incorniciato da un perimetro in finitura brillantata che enfatizza l'unicità del rivestimento e i dettagli materici.

Leather is the most prestigious finish on an executive table. A variety of leather colours are offered in this series always with Pearl Grey color stitching. Each side of the table top is finished with a polished aluminum edge so that the beauty and quality of the leather are highlighted.

Le cuir est le matériel le plus prestigieux pour la table de direction. ARCHIMEDE le propose sur les plateaux en différents coloris avec des surpiqûres en Gris Perle, avec un encadrement brillant qui souligne les détails des matériaux et des revêtements.

El cuero es el material más prestigioso de la mesa ejecutiva. ARCHIMEDE propone sobres de trabajo en una variedad de colores con costuras acabado en Gris Perla, enmarcado por un perímetro en acabado brillante que acentúa la singularidad del revestimiento.



Cuoio - Leather - Cuir - Cuero

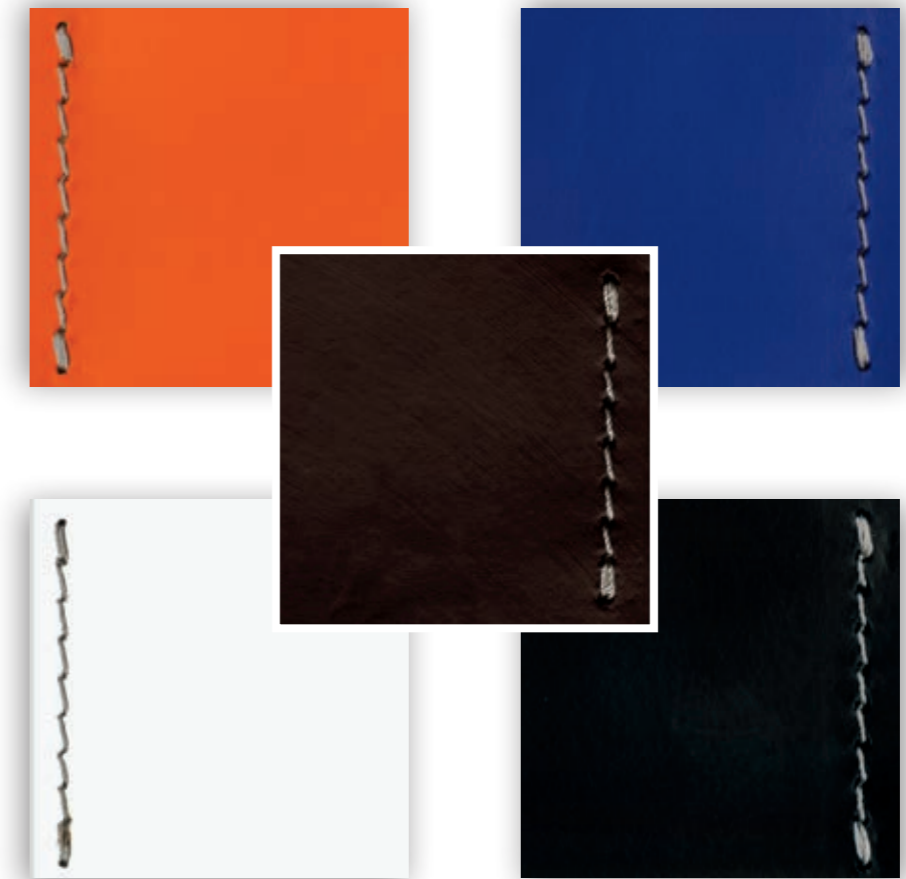

I piani lignei (sia in essenza che in melaminico) presentano una doppia soluzione per il bordo. Lo si può avere sia abbinato alla finitura del piano che realizzato con cornice brillantata. L'abbinamento cromo/legno conferisce un'immagine più tecnica alla scrivania.

The wood tops, both veneer & melamine, come with 2 edge options. It can either match the top or have a polished aluminum finish. The latter provides a more technical look to the desk overall.

Les plateaux (en bois et en mélamine) présentent une double solution pour le chant. Il peut être soit de la même couleur du plateau soit avec encadrement brillant. L'association chrome/bois donne un aspect plus technique au bureau.

Los sobres en madera y melamina presentan una doble solución para el canto. El canto se puede realizar en el mismo acabado que el sobre de mesa o con marco brillante. La combinación de cromo / madera da una imagen más técnica de la mesa.



Legno - Wood - Bois - Madera



Sono numerose le opzioni possibili per i piani in melaminico: dalle finiture legno, ai colori neutri nella esclusiva finitura 'millerighe', alle tinte unite chiare o scure. Le combinazioni realizzabili abbinando struttura metallica e piani sono molte e rendono ARCHIMEDE un prodotto molto versatile e facilmente adattabile ai diversi ambienti di lavoro.

There are many options for melamine tops: from wood finishes to neutral colors in the exclusive "ribbed" finish, to solid bright or dark colors. With multiple pairing options between the metal structure and the worksurfaces, ARCHIMEDE becomes an easy fit for a wide range of working environments.

De nombreuses options sont possibles pour les plateaux en mélaminé: finitions bois, coloris neutres, finition "millerighe", teintes unies claires ou foncées. Les combinaisons possibles avec la structure en métal et les plateaux sont multiples et font d'ARCHIMEDE un produit très flexible et adaptable aux différents aménagements des espaces de travail.

Hay muchas opciones para los sobres en melamina: de los acabados de madera, a los colores neutros en el exclusivo acabado «mil rayas», a los colores lisos brillantes o oscuros. Las diferentes combinaciones mediante la combinación de la estructura metálica y los sobres diferentes acabados en sobres de mesa son muchas y hacen ARCHIMEDE muy versátil y fácilmente adaptable a diferentes ambientes de trabajo.



Melaminico - Melamine - Mélaminé - Melamina



Archimede si arricchisce di una nuova opzione: il piano lavoro in gres porcellanato con telaio perimetrale in alluminio spazzolato. Il piano in gres e' disponibile in quattro finiture di tendenza: corten, basalto, calacatta, pulpis, e rappresenta un'originale alternativa ai materiali tradizionali.

Archimede has been enhanced with a new option: the work tops with porcelain tiles and perimeter frame in brushed aluminum. The porcelain features contemporary finishes: corten, basalt, calacatta and pulpis, and represents a genuine alternative to traditional materials.

Archimede se dote d'une nouvelle option: Un plan de travail en "grès porcelaine" entouré d'une cadre en aluminium brossé. Le plan de grès est disponible en quatre finitions tendances: Corten, Basalte, Calacatta et Pulpis. Ce qui représentent de belles alternatives aux matériaux traditionnels.

Archimede se ha mejorado con una nueva opción: las cubiertas de trabajo con azulejos de porcelana y marco perimetral en aluminio cepillado. La porcelana presenta acabados de moda: corten, basalto, marmol tipo calacatta y piedra pulpis y representa una auténtica alternativa a los materiales tradicionales.



Gres porcellanato - Porcelain tiles - Grès porcelaine Azulejos de porcelana

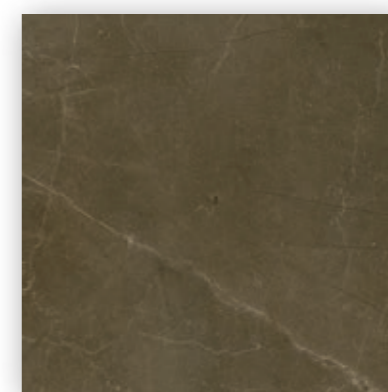
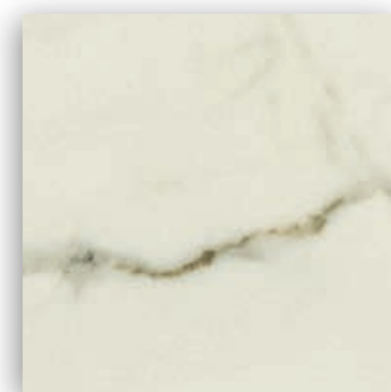

Agli appassionati del vetro, ARCHIMEDE propone piani extra-light retrolaccati in vari colori e incorniciati da una perimetra in alluminio con finitura brillantata. L'immagine che ne deriva è quella di un ambiente molto tecnico, contemporaneo ed elegante.

For the glass lovers, ARCHIMEDE offers extra-light, back painted glass tops available in many colors with a polished aluminum frame. The final result is a sophisticated and contemporary office solution.

Pour les amateurs de verre, ARCHIMEDE propose des plateaux extra-light lacques dans plusieurs finitions avec un contour en aluminium finition brillant conférant à l'espace une image technique, élégant et contemporain.

Para los apasionados del cristal, ARCHIMEDE ofrece sobres extra claros en varios colores y enmarcados por un marco de aluminio con acabado brillante. La imagen que surge es la de un ambiente muy técnico, contemporáneo y elegante.



Vetro - Glass - Verre - Cristal

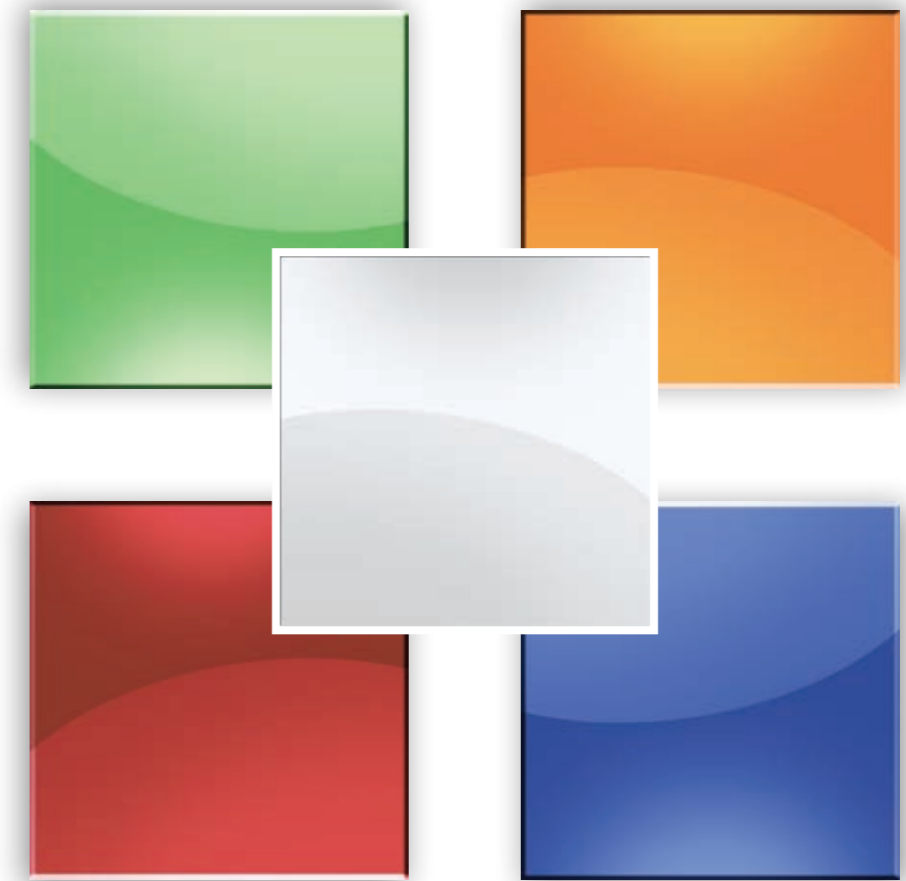



Archimede



The porcelain tops are combined with Romolo sliding doors cabinets featuring the same finish achieved with UV digital printing.

Les surfaces en céramiques sont assorties aux portes coulissantes des cabinets Romolo, présentant les mêmes finitions en utilisant une impression digitale UV.

Las cubiertas de porcelana se combinan con armarios de puertas corredizas Romolo con el mismo acabado realizado con impresión digital UV.



Ai piani in ceramica vengono abbinati contenitori con ante scorrevoli Romolo che presentano la medesima finitura realizzata con stampa digitale UV.

Archimede



Archimede

Archimede





ARCHIMEDE comes with a wide choice of finishes in wood veneer and melamine. A storage system with open bookcases or hinged doors and mobile service units are available as well.

ARCHIMEDE offre une large gamme de choix entre les finitions bois et celles en mélaminé. Viennent compléter les bibliothèques modulaires, ouvertes ou avec portes battantes, et meubles sur roulettes.

ARCHIMEDE ofrece una amplia gama de opciones entre acabados en chapa de madera y melamina. Para completar el mobiliario hay estanterías modulares, abiertas o con puertas batientes, y muebles auxiliares con ruedas.

ARCHIMEDE offre una ampia possibilità di scelta tra le finiture in essenza di legno e quelle in melaminico. A completare l'arredo concorrono librerie modulari, a giorno o con ante battente e mobili di servizio su ruote.

Archimede



Archimede

Oltre alla novità della gamba in finitura cromata, una nuova opzione prevede il contenitore laterale strutturale, dotato di ante scorrevoli e set di cassettiere integrato. Questa soluzione offre all'operatore il vantaggio di avere i propri documenti a portata di mano. Il contenitore è dotato di piedini in metallo in finitura cromata o epossidica abbinata alla gamba.



Besides the leg's new chrome finish, a new side cabinet has been added, with sliding doors and a built-in set of drawers. The user has now a closer access to their everyday files. The cabinet comes with metal supports in either a chrome finish or epoxy painted finish to match the desk legs.

Une nouvelle option, qui s'ajoute aux piétements chromés, est celle du meuble latéral structurel, avec des portes coulissantes et caisson intégré. C'est la solution idéale pour l'utilisateur qui garde ses documents à portée de mains. Ce meuble peut avoir des bases en métal soit en finition chromé soit époxy rappelant les piétements.

Además de la novedad de la pata en acabado cromado, una nueva opción ofrece el contenedor estructural lateral, equipado con puertas correderas y conjunto integrado de cajones. Esta solución ofrece al usuario la ventaja de tener todos sus documentos al alcance. El contenedor está equipado con patas en metal en acabado cromado o epoxy combinada con la pata de la mesa.



Archimede

In this catalogue, the ICARO shelving system has a new version, made with a folded steel sheet epoxy painted. The library is wall mounted with retrofitted brackets and comes with vertical book dividers movable along the shelf.

Le catalogue ARCHIMEDE présente une nouvelle version des bibliothèques modulaires ICARO, réalisées en tôle d'acier plié et verni avec poudre époxy. Elles sont fixées au mur avec des supports invisibles et prévoyant des montants verticaux pour blocage des livres se déplaçant horizontalement le long de l'étagère.

El catálogo Archimede presenta una nueva versión de estanterías modulares ICARO, que ahora se realizan en chapa de acero doblada y pintada con polvos epoxy. La estantería se fija a la pared con soportes retráctiles y está equipada de montantes verticales sujetalibros desplazables horizontalmente a lo largo del estante.



Il catalogo ARCHIMEDE presenta una nuova versione delle librerie modulari ICARO, ora realizzate in lamiera di acciaio piegata e verniciata a polveri epossidiche. La libreria viene fissata a muro con supporti a scomparsa ed è dotata di montanti verticali ferma-libri spostabili orizzontalmente lungo la mensola.

Archimede



Archimede



Archimede

The back painted glass tops framed in polished aluminum are available in many colors and they are a perfect match for bookcases and cabinets in a melamine solid color. ARCHIMEDE legs have always two versions, 'L' or ring-shape.

Le plateau en verre lacqué, avec chant en finition brillant, est disponible dans plusieurs coloris et ABBINARE aux bibliothèques et caissons en mélamine uni. Le piètement d'ARCHIMEDE est toujours disponible en version à anneau linéaire ou moulure.

El sobre en cristal retrolacado, enmarcado por el perfil en acabado brillante, está disponible en varios colores y se combina con estanterías y cajoneras en melamina. La pata de ARCHIMEDE está siempre disponible en dos versiones, o en forma de anillo o en forma de L.



Il piano in vetro retrolaccato, incorniciato dal profilo in finitura brillantata, è disponibile in vari colori e si abbina a librerie e cassetiere in melaminico tinta unita. La gamba di ARCHIMEDE è sempre disponibile nella doppia versione ad anello lineare o sagomato.

Archimede



Archimede

Archimede





Other important new features are the half moon top (available in all the finishes -glass wood - melamine) and a 3 star base very popular for meeting tables.

Autres nouveautés importantes les plateau en demi lune (disponibles dans toutes les finitions verre, bois, mélamine) et le piètement de support avec 3 montants, utilisables également en table de réunion.

Otras novedades importantes, son la península semicircular de reunión (disponible en todas las variantes de acabado cristal - madera - melamina) y la pata de apoyo a tres montantes también para las mesas de conferencia.

Altre novità importanti sono la penisola semicircolare di conversazione (disponibile in tutte le variabili di finitura vetro – legno – melaminico) e la gamba di supporto a tre montanti, utilizzabile anche per i tavoli riunione.

Archimede



Archimede

Archimede





Archimede

Archimede





A flip top is available for meeting tables and comes with a receiving trough for horizontal cable management. A plastic vertebra is provided for the vertical wiring management.

Sur les tables de réunion il est possible d'intégrer des top-access avec corbeille pour le câblage. Les passages de câbles verticaux se font avec des vertèbres en plastique.

En las mesas de reuniones es posible colocar "top-access", equipados de bandeja para los cables. La canalización vertical, se realiza mediante vértebras en material plástico.



Nei tavoli riunione è possibile inserire top-access a doppio verso di apertura, dotati di vasca di appoggio per il cablaggio. La canalizzazione verticale viene affidata a vertebre in materiale plastico.





Archimede

MEL

Melaminico Italian melamine Melaminé Melaminico

 MB	 MG	 MF	 MZ	 MN	 MT
Bianco rigato Rippled effect white Blanc avec rayures Blanco rayado	Grigio rigato Rippled effect grey Gris avec rayures Gris rayado	Nichel Nickel Nickel Niquel	Cacao Cocoa Cacao Cacao	Bianco White Blanc Blanco	Talco Talco Talco Talco
 MJ	 MK	 MI	 MD	 ML	 MQ
Ocra Ochre Ocre Ocre	Safari Safari Safari Safari	Noisette Noisette Noisette Noisette	Ardesia Ardesia Ardesia Pizarra	Nero Black Noir Negro	Blu notte Night blue Bleu nuit Azul noche
 MC	 MY	 ME	 MM	 MO	 MW
Rovere chiaro Light oak Chêne clair Roble claro	Rovere americano American oak Chêne américain Roble americano	Rovere grigio Grey oak Chêne gris Roble gris	Rovere moro Dark oak Chêne foncé Roble oscuro	Noce Canaletto Canaletto Walnut Noyer Canaletto Nogal Canaletto	Noce scuro Dark walnut Noyer foncé Nogal oscuro
Piano Top Plateau Sobre	Modesty panel Modesty panel Voile de fond Faldón	Mobile di servizio Service unit Meuble retour Mueble auxiliar			

VTR

Vetro (anche antimpronta NFG) Glass (also antifinger NFG) Verre (également antitaches)
Vidrio (también anti-huella)

 GF	 GD	 GO	 GR	 GZ	 GW
Goffrato Moka Embossed Mocha Gaufré Moka Gofrado Cafe	Goffrato Indaco Embossed Indigo Gaufré Indigo Gofrado Azul Indigo	Goffrato Rubino Embossed Ruby Gaufré Rubis Gofrado Rubi	Goffrato Cedro Embossed lime green Gaufré vert Cédrat Gofrado verde Cedro	Goffrato Argento Embossed Silver Gaufré Argent Gofrado Plata	Goffrato bianco Embossed white Gaufré blanc Gofrado blanco
 GY	 GQ	 GX	 GK	 GT	 GU
Goffrato nero Embossed black Gaufré noir Lacado negro	Goffrato rosso "F" Embossed red "F" Gaufré rouge "F" Lacado rojo "F"	Goffrato arancione Embossed orange Gaufré indigo Lacado naranja	Goffrato grigio scuro Embossed grey Gaufré gris Lacado gris	Goffrato azzurro Embossed blue Gaufré bleu Lacado azul	Goffrato verde Embossed green Gaufré vert Lacado verde
 GA	 GN				
Ardesia Ardesia Ardesia Pizarra	Noisette Noisette Noisette Noisette				
Piano Top Plateau Sobre					

- Le finiture contenute nel presente catalogo sono puramente indicative e non sono di riferimento per le forniture del prodotto.
- Due to the printing process, finishes shown in this catalogue are for illustration only. The finish on the final item may differ slightly from the printed illustration.
- Les finitions contenues dans ce catalogue ne sont pas contractuelles - les photos ne pouvant rendre la parfaite réalité.
- Los acabados contenidos en este catálogo son puramente indicativos y no son de referencia para los suministros del producto.

- Le finiture contenute nel presente catalogo sono puramente indicative e non sono di riferimento per le forniture del prodotto.
- Due to the printing process, finishes shown in this catalogue are for illustration only. The finish on the final item may differ slightly from the printed illustration.
- Les finitions contenues dans ce catalogue ne sont pas contractuelles - les photos ne pouvant rendre la parfaite réalité.
- Los acabados contenidos en este catálogo son puramente indicativos y no son de referencia para los suministros del producto.

LGN

Legno Wood Bois Madera



Rovere chiaro
Light oak
Chêne clair
Roble claro



Rovere grigio fumo
Smoke grey oak
Chêne gris de fumée
Roble gris humo

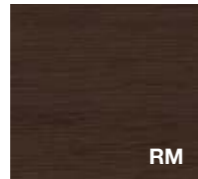

Rovere moro
Dark oak
Chêne foncé
Roble oscuro

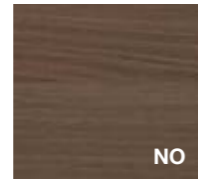

Noce Canaletto
Canaletto walnut
Noyer Canaletto
Nogal Canaletto

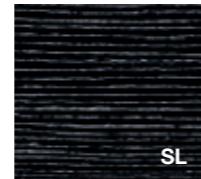

Ebano silver
Silver ebony
Ebony silver
Ebano plata

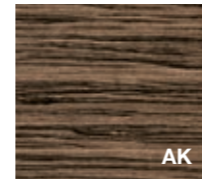

Ebano Makassar
Makassar ebony
Ebony Makassar
Ebano Makassar



Noce termocotto
Heat-treated walnut
Noyer thermo traité
Nogal termotratado

Piano
Top
Plateau
Sobre

Modesty panel
Modesty panel
Voile de fond
Faldón

Mobili di servizio (ante)
Lateral storage units (doors)
Meubles retour (portes)
Muebles de servicio (puertas)

CUO

Cuoio Leather Cuir Cuero

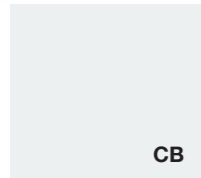

Bianco
White
Blanc
Blanco



Alluminio
Aluminium
Aluminium
Aluminio



Nero
Black
Noir
Negro



Testa di moro
Brown
Tête de maure
Marron oscuro



Caramello
Caramel
Caramel
Caramelo



Arancione
Orange
Orange
Naranja



Indaco
Indigo
Indigo
Azul Indigo

Piano
Top
Plateau
Sobre

- Le finiture contenute nel presente catalogo sono puramente indicative e non sono di riferimento per le forniture del prodotto.
- Due to the printing process, finishes shown in this catalogue are for illustration only. The finish on the final item may differ slightly from the printed illustration.
- Les finitions contenues dans ce catalogue ne sont pas contractuelles - les photos ne pouvant rendre la parfaite réalité.
- Los acabados contenidos en este catálogo son puramente indicativos y no son de referencia para los suministros del producto.

GRES

Gres porcellanato Porcelain tiles Grès cérame Gres porcelánico

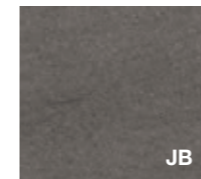

Basalt
Basalt
Basalt
Basalt

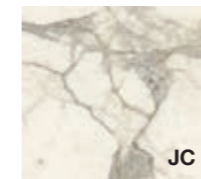

Calacatta
Calacatta
Calacatta
Calacatta

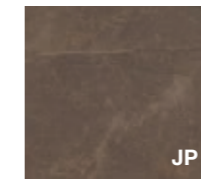

Pulpis
Pulpis
Pulpis
Pulpis

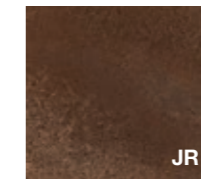

Corten
Corten
Corten
Corten

Piano
Top
Plateau
Sobre

MTC

Metacrilato Metacrylate Méthacrylate Metacrilato

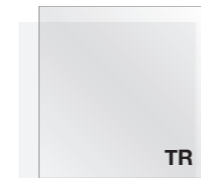

Trasparente
Transparent
Transparent
Transparente



Rosso trasparente
Red transparent
Rouge transparent
Rojo transparente



Blu trasparente
Blue transparent
Bleu transparent
Azul transparente



Bianco satinato
Satin-finish white
Blanc satiné
Blanco satinado



Arancione satinato
Satin-finish orange
Orange satiné
Naranja satinado



Blu satinato
Satin-finish blue
Bleu satiné
Azul satinado



Verde satinato
Satin-finish green
Vert satiné
Verde satinado



Grigio fumè satinato
Satin-finish smoky grey
Gris satiné
Gris satinado



Bianco opalino
Opaline white
Blanc opalin
Blanco opaco

Mobili di servizio (ante)
Lateral storage units (doors)
Meubles retour (portes)
Muebles de servicio (puertas)

- Le finiture contenute nel presente catalogo sono puramente indicative e non sono di riferimento per le forniture del prodotto.
- Due to the printing process, finishes shown in this catalogue are for illustration only. The finish on the final item may differ slightly from the printed illustration.
- Les finitions contenues dans ce catalogue ne sont pas contractuelles - les photos ne pouvant rendre la parfaite réalité.
- Los acabados contenidos en este catálogo son puramente indicativos y no son de referencia para los suministros del producto.

GOF

Metacrilato retrolaccato Backpainted acrylic Méthacrylate rétro-laqué Metacrilato retrolacado



Goffrato Moka
Embossed Mocha
Gaufré Moka
Gofrado Cafe

Goffrato Indaco
Embossed Indigo
Gaufré Indigo
Gofrado Azul Indigo

Goffrato Rubino
Embossed Ruby
Gaufré Rubis
Gofrado Rubi

Goffrato Cedro
Embossed lime green
Gaufré vert Cédral
Gofrado verde Cedro

Goffrato Argento
Embossed Silver
Gaufré Argent
Gofrado Plata

Goffrato bianco
Embossed white
Gaufré blanc
Gofrado blanco



Goffrato nero
Embossed black
Gaufré noir
Lacado negro

Goffrato rosso "F"
Embossed red "F"
Gaufré rouge "F"
Lacado rojo "F"

Goffrato arancione
Embossed orange
Gaufré indigo
Lacado naranja

Goffrato grigio scuro
Embossed grey
Gaufré gris
Lacado gris

Goffrato azzurro
Embossed blue
Gaufré bleu
Lacado azul

Goffrato verde
Embossed green
Gaufré vert
Lacado verde



Ardesia
Ardesia
Ardesia
Pizarra

Noisette
Noisette
Noisette
Noisette

Mobili di servizio (ante)
Lateral storage units (doors)
Meubles retour (portes)
Muebles de servicio (puertas)

EPX

Epossidico Epoxy Epoxyde Epoxídico

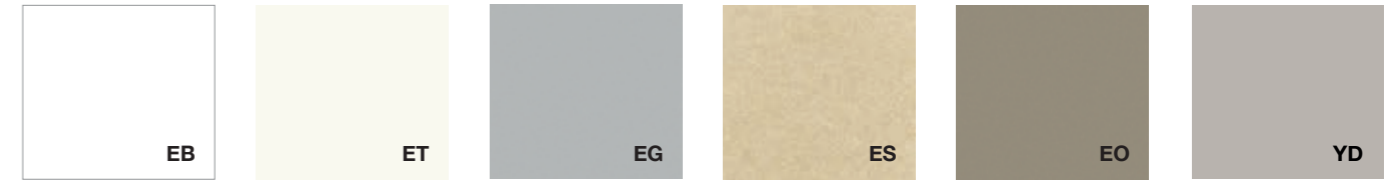

Bianco
White
Blanc
Blanco

Talco
Talco
Talco
Talco

Grigio
Grey
Gris
Gris

Sabbia
Cream
Sable
Arena

Noisette
Noisette
Noisette
Noisette

Beige Arizona
Arizona beige
Beige Arizona
Beige Arizona



Blu notte
Night blue
Bleu nuit
Azul noche

Grigio Bromo
Bromo grey
Gris Bromo
Gris Bromo

Ardesia
Ardesia
Ardesia
Pizarra

Verde Oliva
Olive green
Olive vert
Verde oliva

Oro
Gold
Or
Oro

Rame
Copper
Cuivre
Cobre

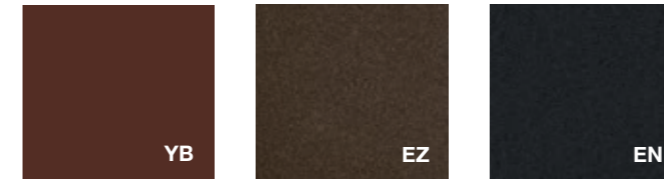

Rosso Jaipur
Jaipur red
Rouge Jaipur
Rojo Jaipur

Bronzo
Bronze
Bronze
Bronce

Nero
Black
Noir
Negro

Gamba
Leg
Pied
Pata

CRM

Acciaio Steel Acier Acero

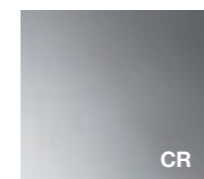

Acciaio inox
Stainless steel
Acier inoxydable
Acero inoxidable

Gamba
Leg
Pied
Pata

BR

Brill Brill Brill Brill



Brill
Brill
Brill
Brill

Profilo piano scrivania
Top edge
Chant plateau
Perfil sobre de mesa

- Le finiture contenute nel presente catalogo sono puramente indicative e non sono di riferimento per le forniture del prodotto.
- Due to the printing process, finishes shown in this catalogue are for illustration only. The finish on the final item may differ slightly from the printed illustration.
- Les finitions contenues dans ce catalogue ne sont pas contractuelles - les photos ne pouvant rendre la parfaite réalité.
- Los acabados contenidos en este catálogo son puramente indicativos y no son de referencia para los suministros del producto.

ecologia

Alea utilizza per i suoi prodotti e i suoi imballi materiali facilmente separabili e riciclabili.

attestazione di prodotto

I prodotti Alea sono stati sottoposti a prove prestazionali presso laboratori di prova accreditati. Copia dei rapporti di prova o delle attestazioni di conformità sono disponibili su richiesta. I prodotti Alea soddisfano i requisiti LEED per il credito IEQ4.5 per i materiali a bassa emissione ed i requisiti ANSI/BIFMA X7.1-2011. Alea dichiara di utilizzare pannelli a base di legno aventi un rilascio di formaldeide conforme alla classe E1 secondo il DM 10/10/2008. Alea si impegna inoltre ad utilizzare materiali legnosi FSC e pannelli a base di legno con certificazione CARB2.

environment

Alea products and packaging are made of recyclable materials.

product certification

Alea products have been subjected to performance tests at accredited testing laboratories. Copies of test reports or certificates of conformity are available on request. Alea products meet the LEED requirements for IEQ4.5 credit for low emission materials and the ANSI/BIFMA X7.1-2011 requirements. Alea declares to use wood-based panels with a formaldehyde release according to class E1 according to DM 10/10/2008. Alea also undertakes to use FSC wood-based materials and CARB2-certified wood-based panels.

environnement

Alea utilise des matériaux facilement séparables et recyclables pour ses produits et ses emballages.

certification de produits

Les produits Alea ont été soumis à des tests de performance dans des laboratoires accrédités. Des copies des rapports d'essais ou des certificats de conformité sont disponibles sur demande. Les produits Alea répondent aux exigences LEED pour le crédit IEQ4.5 pour les matériaux à faibles émissions et aux exigences ANSI/BIFMA X7.1-2011. Alea déclare utiliser des panneaux à base de bois avec un dégagement de formaldéhyde selon la classe E1 selon DM 10/10/2008. Alea s'engage également à utiliser des matériaux à base de bois FSC et des panneaux à base de bois certifiés CARB2.

ecología

Alea utiliza productos y embalajes en materiales fácilmente separables y reciclables.

certificación de producto

Los productos Alea han sido sometidos a pruebas de rendimiento en laboratorios de pruebas acreditados. Copias de los informes de las pruebas o certificados de conformidad están disponibles bajo petición. Los productos Alea cumplen con los requisitos LEED para el crédito IEQ4.5 para materiales de baja emisión y los requisitos ANSI/BIFMA X7.1-2011. Alea declara utilizar paneles de madera con una emisión de formaldehído según la clase E1 según DM 10/10/2008. Alea también se compromete a utilizar materiales a base de madera FSC y paneles a base de madera certificados por CARB2.

concept & graphic design

Alea marketing + communication

design

Filippon & Mirto Antonel

art direction

Mirto Antonel

AF/CACB/AB



GLOBAL HEADQUARTERS AND SHOWROOM : Via Col de Rust, 19 - 33070 Sarone (PN) - Italia : Tel ++39 0434 777 333
email: info@aleaoffice.com **PARIS SHOWROOM** : 176 Avenue Charles de Gaulle 92200, Neuilly-sur-Seine - France **NORTH AMERICAN**
HEADQUARTERS : Midtown 2, 3449 NE 1st Avenue L-32, Miami, FL 33137 - USA : Tel ++1 305 470 1200 - email: info@alea-usa.com
ALEA UK OFFICE AND SHOWROOM : 50-54 Clerkenwell Road, London EC1M 5PS - email: info@aleaoffice.com